

DISHWASHER

use & care

Important Safety Instructions.....	2	Dishwasher Dispenser and Detergents	10
Product Registration	3	Factors Affecting Performance	11
Features at a Glance.....	4	Care and Cleaning	12-13
Operating Instructions	5-6	Before you Call.....	13-15
Preparing and Loading Dishes	7-9	Major Appliance Warranty	16

IMPORTANT SAFETY INSTRUCTIONS



WARNING

Please read all instructions before using this dishwasher.

For your Safety

- Use your dishwasher only as instructed in this Use and Care Manual.
- This Manual does not cover every possible condition and situation that may occur. Use common sense and caution when installing, operating and maintaining any appliance.
- NSF certified residential dishwashers are not intended for licensed food establishments.
- **DISHWASHER MUST BE ELECTRICALLY GROUNDED.** Read the Installation Instructions for details.
- This dishwasher is designed to operate on regular house current (120V, 60Hz). Use a circuit equipped with a 15 ampere fuse or circuit breaker. Use a 20 ampere fuse if dishwasher is connected with a food disposer.
- Do not operate dishwasher unless all enclosure panels are in their proper place.
- To avoid entrapment and/or suffocation, remove door or door latch mechanism from any dishwasher that is discarded or not in use.
- Keep young children and infants away from dishwasher when it is operating.
- Do not let children abuse, sit, stand or play on door or racks of a dishwasher.
- Use only detergents and rinse agents recommended for use in a dishwasher.
- Store dishwasher detergent and rinse agents out of the reach of children.
- Do not wash plastic items unless marked: "Dishwasher Safe" or equivalent. Check with manufacturer for recommendations, if not marked. Items that are not marked dishwasher safe may melt and create a potential fire hazard.
- Disconnect electrical power to dishwasher before servicing.
- If the dishwasher drains into a food disposer, make sure disposer is completely empty before running dishwasher.
- Repairs should be done by a qualified technician.
- Do not tamper with controls.
- Do not touch the heating element during or immediately after wash has completed.
- Use care unloading the dishwasher when the SANITIZE option has been selected. Contents may be hot to the touch immediately after the end of cycle.
- Water vapor from the vent may be hot to the touch when the SANITIZE option has been selected. Use care and do not let small children play around or touch the vent area of the dishwasher.
- When loading items to be washed:
 - Locate sharp items and knives so that they are not likely to damage the door seal or tub.
 - Load sharp items and knives with the handles up to reduce the risk of cut-type injuries.
 - Under certain conditions, hydrogen gas may be produced in a hot water, system that has not been used for 2 weeks or more. **HYDROGEN GAS IS EXPLOSIVE.** If hot water system has not been used for such a period, before using dishwasher, turn on for several minutes This will release any accumulated hydrogen gas. **HYDROGEN GAS IS FLAMMABLE.** Do not smoke or use an open flame during this time.
 - Do not store or use combustible materials, gasoline or other flammable vapors and liquids in the vicinity of this or any other appliance.



WARNING

To reduce the risk of fire, electrical shock or injury when using your dishwasher, follow the above basic precautions ..



WARNING

This symbols will help alert you to such dangers as personal injury, burns, fire and electrical shock..

Thank you for choosing **Frigidaire**

This Use & Care Guide is part of our commitment to customer satisfaction and product quality throughout the service life of your new appliance.

We view your purchase as the beginning of a relationship. To ensure our ability to continue serving you, please use this page to record important product information.

Purchase Date

Model Number

Serial Number

Registering your product with Frigidaire enhances our ability to serve you. You can register online at **www.frigidaire.com** or by dropping your Product Registration Card in the mail.



Very Important Information
- **Read Before Operating Your Dishwasher!**

Normal Operating Sounds

This dishwasher does not sound like most dishwashers - **IT'S QUIETER.**

Your Precision Direct Wash System dishwasher uses energy efficient motors for the wash and drain portions of the cycle you select. Each cycle has a series of water fills and drains for washing and rinsing dishes. As each cycle begins, you may - or may not - hear the drain motor.

The next sound you will hear is the splashing water as it enters the tub. Then the lower arm rotates and circulates water. This is followed by a pause and a slightly different sound as the upper arms spray water. If you listen closely, you will hear the change in sound as the wash action switches from one arm to the other.

PLEASE BE ADVISED: If you compare this dishwasher to previous models, you may be surprised at what you **DON'T** hear.

FEATURES AT A GLANCE

Your dishwasher cleans by spraying a mixture of hot water and detergent through the spray arms against soiled surfaces. First, the dishwasher fills with water covering the filter area. Water is then pumped through the spray arms. Soil particles go through and across the filter and down the drain as the water is pumped out. This series of steps are repeated as needed. The number of water fills vary with the cycle being used.

Features may vary according to model

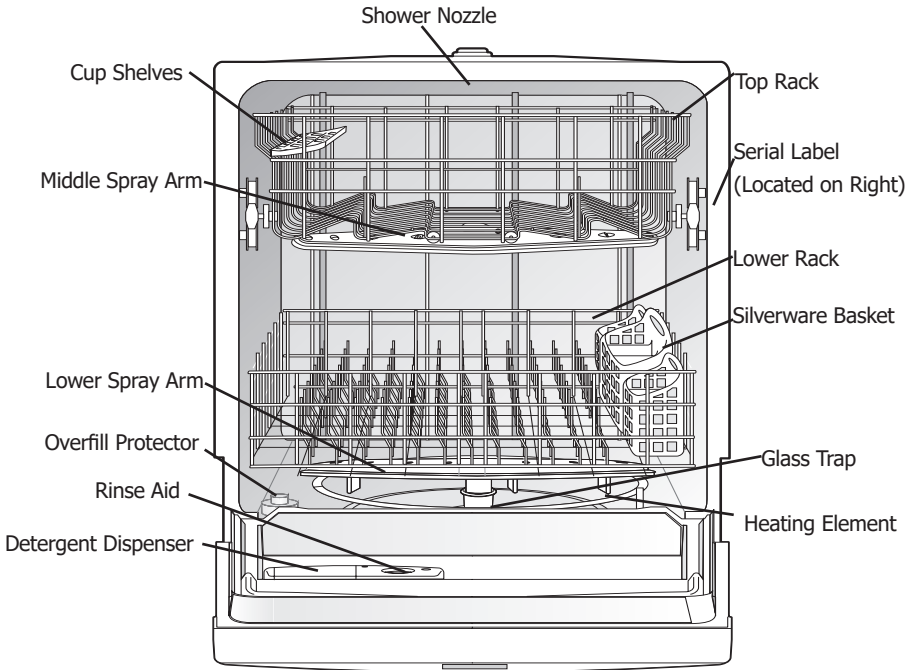

Getting Started

1. Load Dishwasher (See Preparing and Loading Dishes).
2. Add detergent (See Dishwasher Dispenser & Detergents).
3. Add Rinse Aid, if needed (See Rinse Aid).
4. Close door to latch.
5. Select desired CYCLE (See Cycle Chart). The indicator light above the pad will glow when selected.
6. Select desired OPTION (See Energy Options). The indicator light above the pad will glow when selected.
7. Run hot water faucet nearest dishwasher until water is hot. Turn water off.
8. To start, press START/CANCEL pad.

NOTE

The dishwasher is programmed to remember your last cycle so you do not have to reset each time. To start the dishwasher using the same cycle and options selected on the previous wash, just press the START/CANCEL pad.

Wash Cycle Selections

Cycle times are approximate and will vary with options selected. Hot water is necessary to activate dishwasher detergent and melt fatty food soils. An automatic sensor will check the incoming water temperature and, if it is not hot enough, the cycle will be lengthened for automatic water heating in the main wash and final rinse of all cycles. This happens even when HIGH TEMP WASH option has not been selected. When HIGH TEMP WASH is selected, an even higher temperature will be reached to handle heavier soil loads.

OPERATING INSTRUCTIONS

Option Selections

Sanitize Option

To sanitize your dishes and glassware, select **SANITIZE** option. When selected, the light above the pad will come on and remain on until end of cycle. The water temperature in the final rinse will be raised to 155°F (68°C) and will maintain that temperature for 9 minutes. This option is available in Heavy and Normal Cycles. Only these sanitization cycles have been designed to meet NSF requirements.

The cycle time will be extended until the proper water temperature is reached. Washing action will continue during the water heating delay. For best results, the incoming water temperature should be at least 120°F (49°C).

The sanitize criteria may not be satisfied if there is an interruption of the cycle, power failure or if the incoming water temperature is below 120°F (49°C).

To turn off the **SANITIZE** option, press the pad a second time. The light above the pad will turn off.

High Temp Wash Option

When **HI-TEMP WASH** option is selected, the dishwasher heats water in the main wash to approximately 140°F (60°C).

This increase in water temperature helps the dishwasher detergent remove food grease and soil from dishes more effectively and aids in improved drying performance. **HIGH TEMP WASH** option can be used with all cycles except **RINSE ONLY**. **HIGH TEMP WASH** is automatically provided when the **HEAVY WASH** cycle is selected.

When **HIGH TEMP WASH** option is selected, the light above the pad will come on and remain on until end of cycle. To turn off the **HIGH TEMP WASH** option, press the pad a second time. The light above the pad will turn off.

Heat Dry

The **HEAT DRY** option in combination with rinse aid will enhance drying performance. The energy required to use the **HEAT DRY** option costs pennies per cycle; however you will have items in your dish load that will not be completely dry at the end of the cycle.

Drying Tip

Select the **NORMAL WASH** and **HI-TEMP WASH** pads along with a Rinse Aid agent for improved drying performance.

To Cancel a Cycle

You can cancel a cycle anytime during the cycle. Press and hold the **START/CANCEL** pad for 3 seconds. The light above the cycle and option

selected will go out, the **START/CANCEL** light will remain illuminated, the dishwasher will start a 90 second drain. At the end of the drain, select the next desired cycle.

Delay Start

The **DELAY START** option allows you to automatically delay starting your dishwasher for 4 hours.

To activate delay start option for 4 hour delay, press the **OPTIONS** pad once. A light will come on indicating the delay start hours and will remain on until cycle starts. Press the **START/CANCEL** pad to start the delay option. If the delay option is interrupted, the **START/CANCEL** pad will have to be pressed again to return to delay option.

To cancel the **DELAY START** option and begin the cycle before the delay period is over, press and hold the **START/CANCEL** pad for 3 seconds.

Child Lock Controls

To prevent children from accidentally changing the dishwasher cycle or starting the dishwasher, lock the dishwasher controls by pressing the **OPTIONS** pad for 3 seconds while the door is latched. An indicator light on the lock graphic pad will illuminate when the controls are locked and no new selections can be made until the lock is released. To unlock the controls, press the same pad, **OPTIONS**, again for 3 seconds until the indicator light goes out.

Status Indicator Lights

When the **SANITIZE** option is selected, the **SANITIZED** light will glow when the **SANITIZE** cycle is finished. If the dishwasher did not properly sanitize the dishes, the light will not come on. This can happen if the cycle is interrupted. The light will remain on until the door is opened.

The **CLEAN** light will come on at the end of cycle and remain on until the door is opened.

NOTE

If the dishwasher door is opened while the unit is running, the **START/CANCEL** pad must be pressed and the door shut immediately to return the unit to the selected cycle and option, this must happen within 10 minutes for the unit to continue the cycle.

NOTE

Not all cycles and options available on all models.

OPERATING INSTRUCTIONS

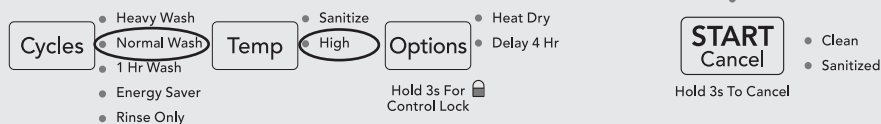

* Select the NORMAL WASH and HI-TEMP WASH pads along with a Rinse Aid agent for improved drying performance.

Cycle and Option Chart

Cycle and intended use	Available Options Temperature; Drying	Water per Cycle (approx.)	Duration* (approx.)
Heavy Wash Recommended for pots, pans, casseroles and dinnerware having light to heavily soiled loads.	Sanitize, Hi-Temp Heat Dry, Air Dry	9 gal. 34 L.	2 - 3 Hours
Normal Wash* Recommended for lightly to heavily soiled loads.	Sanitize, Hi-Temp*, Normal; Heat Dry, Air Dry	3.2 - 7 gal. 12 - 26 L.	1 1/4 - 3 Hours
1 Hr Wash Recommended for lightly soiled loads only.	Hi-Temp, Normal Heat Dry, Air Dry	4.3 gal. 16 L.	1 Hour
Energy Saver A cycle used to reduce dishwasher energy consumption.	Normal Heat Dry, Air Dry	4.5 gal. 17 L.	1 - 2 1/4 Hours
Rinse Only For rinsing dishware that will be washed later.	N/A	2.3 gal. 9 L.	17 Mins. (Air Dry Only)

*Does not include drying time.

PREPARING AND LOADING DISHES

Dish Preparation

Scrape away large pieces of food, bones, pits, toothpicks, etc. The continuously filtered wash fluid will remove remaining food particles. Burned-on foods should be loosened before loading. Empty liquids from glasses and cups.

Foods such as mustard, mayonnaise, vinegar, lemon juice and tomato based products may cause discoloration of stainless steel and plastics if allowed to sit for a long period of time. Unless the dishwasher is to be operated at once, it is best to pre-rinse or use the rinse only cycle to rinse off these food soils.

- Load racks so that large items do not prevent the detergent dispenser from opening.
- Check manufacturer's recommendations before washing items in question.
- If the dishwasher drains into a Food Disposer, **be sure disposer is completely empty before starting dishwasher.**

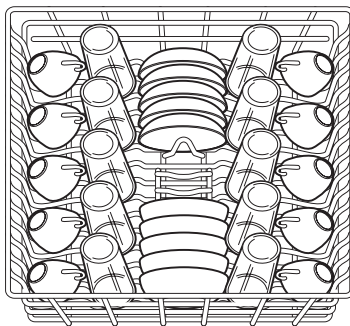
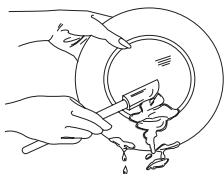

10 place settings standard loading pattern

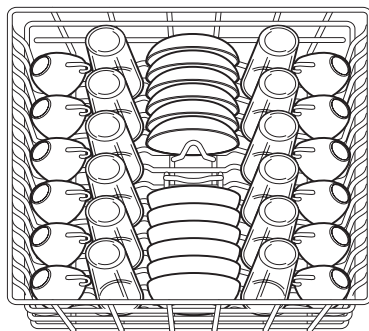

12 place settings standard loading pattern

Loading the Top Rack

Features and appearance of racks and silverware basket may vary from your model.

The upper rack is designed for flexibility in loading a wide variety of items including cups, glasses, stemware, small plates, bowls, etc.

Load glasses in top rack only. Damage may occur if placed in bottom rack.

Load plastic items in top rack only. Melting may occur if placed in bottom rack.

Load items with open ends facing down for better cleaning and draining.

Damage may occur if delicate items touch each other during dishwasher operation.

Long-handled knives and utensils can be placed in top rack.

Be sure nothing protrudes through the bottom of the rack to block rotation of middle spray arm.

Some models have a fold-down cup shelf or a cup shelf/stemware holder. They can be used to load two levels of cups, juice glasses, and other short items. Stagger items on upper level so that water can reach all inside surfaces. Fold up to load tall glasses.

PREPARING AND LOADING DISHES

Upper Rack

The UPPER RACK option can be used to wash a wide assortment of items when you don't have a full load. Also, when the upper rack fills up with glasses and the lower rack is still empty, you don't have to wait anymore for clean glasses.

STEMWARE HOLDER/CUPSHELF not available on all models.

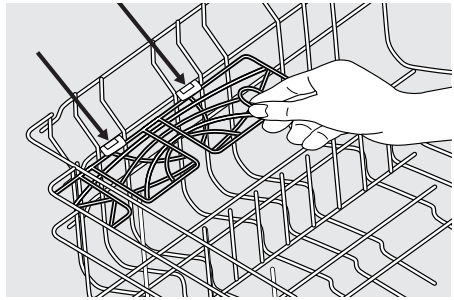
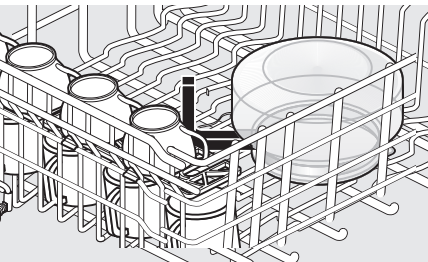
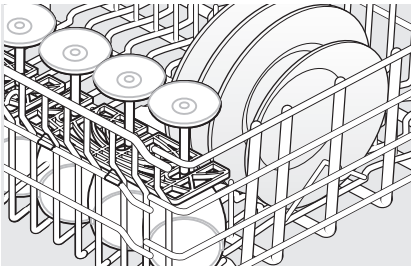
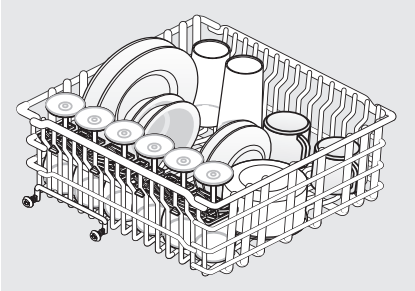

Place the clips of the cup shelf over the horizontal rack wires and push down to attach the cup shelf onto the second wire of the upper rack.

Loading the Bottom Rack

Features and appearance of racks and silverware basket may vary from your model.

The lower rack is best for plates, saucers, bowls, and cookware. Large items should be placed along the edge so they do not block the spray arm rotation. For best results, place bowls, casseroles, and sauce pans with soiled surface facing down or toward the center. Tilt slightly for better drainage.

Make sure tall items do not block spray arm rotation.

Be sure pan handles do not protrude through the bottom of the rack and block the spray arm rotation.

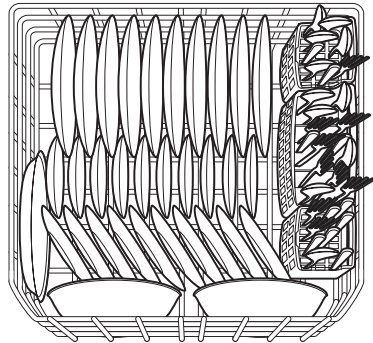

10 place settings standard loading pattern.

PREPARING AND LOADING DISHES

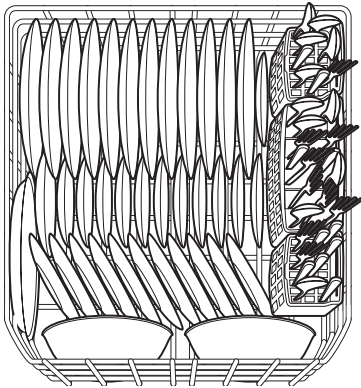

12 place settings standard loading pattern.

Use suggested loading patterns, as shown, to increase washability of the silverware.

Be sure nothing protrudes through bottom of basket or rack to block the spray arm.

Do not mix silver and stainless to avoid damaging the silver finish.

When covers are up, mix items in each section of the basket with some pointing up and some down to avoid nesting. Water spray cannot reach nested items.

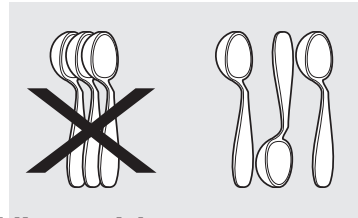

Loading the Silverware Basket



CAUTION

Load sharp items (knives, skewers, etc.) pointing down.

Failure to do so may result in injury.

Features and appearance of racks and silverware basket may vary from your model.

Load the silverware basket while it is in the bottom rack or take the basket out for loading on a counter or table.

Adding a Dish

To add or remove items after wash cycle starts:

- Unlatch door and wait a few seconds until wash action stops before opening.
- Add the item and wait a few seconds to allow cold air to slowly expand inside dishwasher.
- Close door firmly to latch and press the START/CANCEL pad to resume.

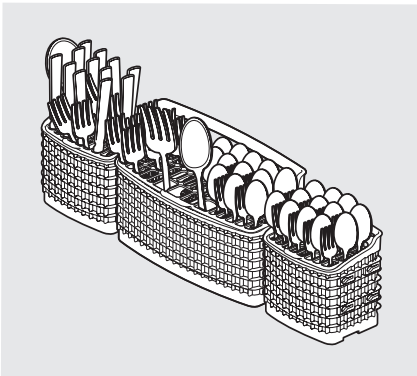

DISHWASHER DISPENSER & DETERGENTS



CAUTION

The use of industrial grade detergent can damage the heating coil and other parts of the dishwasher leading to damage to the unit and surrounding property. Use only household grade automatic dishwasher detergents.

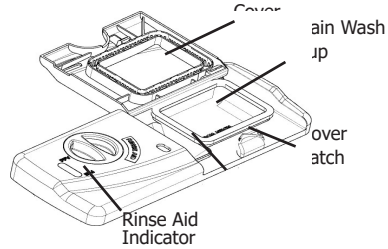

Filling the Detergent Dispenser

The detergent dispenser has two detergent cups. The smaller one is for addition to the pre-wash and the larger is for release to the main wash.

- Use only fresh automatic dishwashing detergent. Other detergents may cause oversudsing.
- When using automatic dishwashing detergent tabs, place one tab in main wash cup and close.
- Add detergent just before starting cycle.
- Store detergent in a cool, dry location. Moist or caked detergent may not dissolve properly.

If the cover is closed on the Main Wash Cup open by pressing the Cover Latch.

How much Detergent to use

The amount of detergent to use depends on the water hardness. Water hardness is measured in grains per gallon. Using too little detergent can result in poor cleaning and hard water filming or spotting. Using too much detergent in soft water can cause etching to some glassware which is surface damage that appears like a film but cannot be wiped off. Your local water company, water softener company or county extension agent can tell you the water hardness in your area.

Detergent Usage Chart				
Cycle	Soft Water (0-3 grains)	Medium Hard Water (4-8 grains)	Hard Water (9-12 grains)	Very Hard Water (Over 12 grains)
Heavy Wash or Normal Wash	2 teaspoons (each cup- 1/4 full)	5 teaspoons (each cup- fill to line above "Regular")	8 teaspoons (each cup- completely full)	Each Cup- Completely Full (water softener recommended)
1 Hr. Wash or Energy Saver	2 teaspoons (Main Wash cup- 1/4 full)	5 teaspoons (each cup- fill to line above "Regular")	8 teaspoons (Main Wash cup- completely full)	Main Wash Cup- Completely Full (water softener recommended)
Rinse Only	No Detergent	No Detergent	No Detergent	No Detergent (water softener recommended)

As a rule, use 1 teaspoon for each grain above 12. For very hard water, detergent alone may not be enough and then a water softener is recommended to improve water quality and dishwashing performance.

FACTORS AFFECTING PERFORMANCE

Rinse Aid

Rinse aid greatly improves drying, reduces water spots, filming, and lubricates wash arm bearing for proper rotation. With it water “sheets” off dishes rather than forming water droplets that cling and leave spots.

A dispenser, located next to the detergent cup, automatically releases a measured amount of rinse aid during the last rinse. If spotting and poor drying are problems, increase the amount of rinse aid dispensed by rotating the dial to a higher number. The dial is located under the dispenser cap. The indicator will be dark when full and will show clear when it is time to refill.

To add liquid rinse aid, turn dispense cap 1/4 turn counterclockwise and lift out. Pour in rinse aid until liquid touches the indicated fill level. Replace cap.

Do not overfill since this can cause oversudsing. Wipe up any spills with a damp cloth.

The dispenser holds enough for 35 to 140 washes, depending on setting.

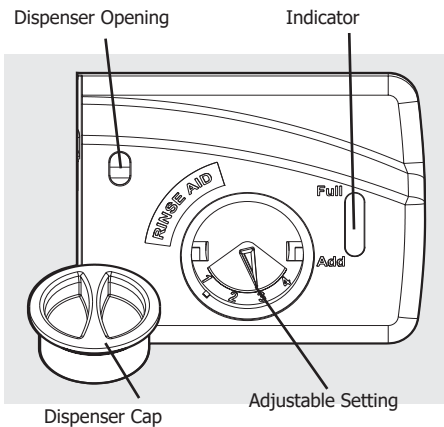

The HEAT DRY option in combination with rinse aid will enhance drying performance. The energy required to use the HEAT DRY option costs pennies per cycle. You may choose not to select the HEAT DRY option; however you will have items in your dish load that will not be completely dry at the end of the cycle.

Water Pressure

The hot water line to dishwasher must provide water pressure between 20 and 120 psi.

Low Water pressure may occur when laundry or showers are in operation. If you experience poor wash performance you may need to wait until water use is reduced before starting dishwasher.

Water Temperature

Hot water is needed for best dishwashing and drying results. Water entering dishwasher should be at least 120°F (49°C) to give satisfactory results.

To check water temperature entering dishwasher:

- Turn on hot water faucet nearest dishwasher for several minutes to clear cool water from pipes.
- Hold a candy or meat thermometer in the water stream to check the temperature.
- If temperature is below 120°F (49°C), have a qualified person raise the hot water heater thermostat setting.



IMPORTANT

Before starting a cycle, run hot water to clear cool water from pipe.

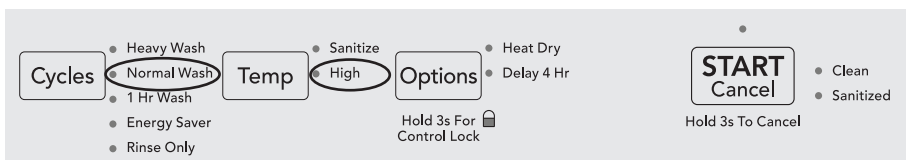

* Select the NORMAL WASH and HI-TEMP WASH pads along with a Rinse Aid agent for improved drying performance.

CARE AND CLEANING

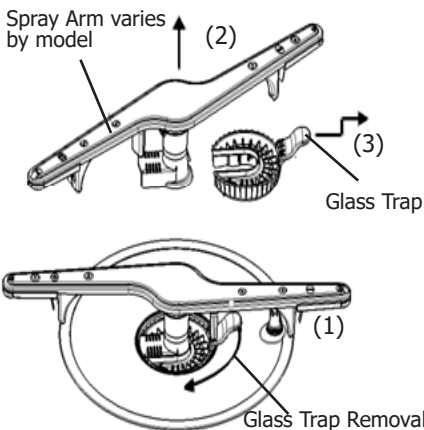

To empty the glass trap:

1. Grasp the glass trap's handle and rotate it 90° clockwise while pressing down on the center of the wash arm.
2. Grab the spray arm in the center and lift the spray arm and glass trap assembly up and out from the dishwasher.
3. Tip the assembly over an appropriate container and tap it to empty the glass trap.
OR, separate the glass trap - pull the glass trap handle toward you, then up, then further toward you to slide it away from the rest of the assembly; empty it into an appropriate container; then slide the glass trap back into the assembly.
4. Place the assembly back into position, press down on the arm at the center and rotate the glass trap handle 90° counterclockwise being sure the glass trap ends in the orientation shown in the image above. **To avoid damage to your unit make sure the spray arm and glass trap are fully snapped in place.**

NOTE

Hard water may cause lime deposit buildup on the interior of the dishwasher. For cleaning instructions see "Removing Spots and film" section.



WARNING



Burn Hazard

Allow heating element to cool before cleaning the interior.

Failure to do so can result in burns.

Outer Door - Clean outer door with warm soapy water and a dishcloth or sponge. Rinse with clean water and a dry cloth. Do not use harsh cleaners.

Inside - The inside of the dishwasher and filter are self-cleaning with normal use. If needed, clean around the tub gasket area with a damp cloth. The filter is self-cleaning. A glass trap located in the center of the filter is designed to collect pieces of broken glass, straws, bones and pits.

Overflow Protector- keeps dishwasher from overflowing and is located in the left front corner of the tub.

- Clean occasionally with household cleaner containing vinegar or bleach to dissolve any buildup.
- Overflow Protector should move up and down freely about one inch. If it does not move, lift and clean underneath.

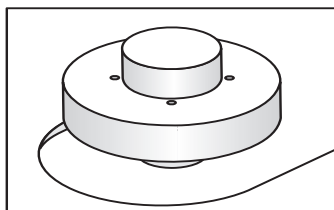

Care of Drain Air Gap

If a drain air gap was installed for your built-in dishwasher, check to make sure it is clean so the dishwasher will drain properly. A drain air gap is usually mounted on countertop and can be inspected by removing the cover. This is not part of your dishwasher and is not covered by warranty.

Winterizing

A dishwasher left in an unheated place should be protected from freezing. Have a qualified person do the following:

To Disconnect Service:

1. Turn off electrical power to the dishwasher at the supply source by removing fuses or tripping circuit breaker.
2. Shut off water supply
3. Place a pan under the inlet valve. Disconnect water line from inlet valve and drain into pan.
4. Disconnect drain line from pump and drain water into pan.

To Restore Service:

5. Reconnect the water, drain, and electrical power supply.
6. Turn on water and electrical power supply
7. Fill both detergent cups and run dishwasher through a HEAVY WASH cycle.
8. Check connections to make sure they do not leak.



NOTE

See Installation Instructions for more details on disconnecting and restoring service to your dishwasher.

Before You Call

Before calling for service, review this list. It may save you both time and expense. This list includes common experiences that are not the result of defective workmanship or material in your dishwasher.

Food Soils Left on Dishes

- Choose another cycle for longer washing time.
- Check rack loading section for proper loading-avoid nesting items.
- Do not overload the dishwasher (See Preparing and Loading Dishes).
- Check to verify that the glass trap is maintained and installed properly (See Care and Cleaning). Home water pressure may be too low-should be 20 to 120 pounds per square inch (psi).

- Check incoming water temperature. It should be about 120°F (49°C). (See Factors Affecting Performance).
- Check water hardness. For extremely hard water, it may be necessary to install a water softener. (See Detergent Chart).
- Use Fresh Detergent.
- Make sure items are not blocking the spray arms, preventing them from rotating.

Dishes not Dry

- By selecting Heat Dry, Hi-Temp Wash or Sanitize options this will improve drying.
- Make sure the rinse aid dispenser is filled.
- Increase the discharge setting of rinse aid. (See Rinse Aid).
- Check the incoming water temperature. Be sure it is at least 120°F (49°C).
- Check for proper loading-avoid nesting items.
- Plastic items may need to be towel dried.
- Cups with a concave bottom will collect water. Load them at the far left of the upper rack so they will be held in a tilted position.
- Containers, bowls, pots/pans, and any dishware with concave surfaces that can collect water should be placed in the rack facing or angled down so that water is able to drain even from the lowest point.

Drying Tip

- Select the NORMAL WASH and HI-TEMP WASH pads along with a Rinse Aid agent for improved drying performance.

Glassware/Flatware Spotted or Cloudy

- Check water hardness. For extremely hard water, it may be necessary to install a water softener. (See Detergent Chart).
- Water temperature may be low. Avoid extremely low or high temperatures. (See Factors Affecting Performance).
- Avoid overloading and improper loading. (See Preparing and Loading Dishes).
- Use fresh detergent. Old detergent is ineffective.
- Make sure rinse aid dispenser is filled.
- Check to see that proper amount of detergent is being used for cycle selected. (See Detergent Dispenser).
- Home water pressure may be too low-it should be 20 to 120 pounds per square inch (psi).

BEFORE YOU CALL

Dishware Chipped

- Load with care and do not overload. (See Preparing and Loading Dishes).
- Place delicate items in top rack.
- Place glasses securely against pins and not over pins.
- Load items so they are secure and don't jar loose when moving racks in and out. Move racks in and out slowly.
- Make sure tall glasses and stemware will clear top of tub when rack is pushed in.
- Fine antique china and crystal should be hand-washed.

Dishware Stained or Discolored

- Tea and coffee can stain cups. Remove the stains by hand washing in a solution of 1/2 cup (120 ml) bleach and one quart (1L) of warm water. Rinse thoroughly.
- Iron deposits in water can cause a yellow or brown film. A special filter installed in the water supply line will correct this problem. (See Removing Spots and Film).
- Aluminum utensils can leave gray/black marks when they rub against other items. Load Properly.
- Certain high acid foods can cause discoloration of stainless steel and plastics if allowed to sit for a long period. Use the Rinse Only cycle or rinse by hand if not operating dishwasher at once.
- Mixing stainless steel and silver utensils in silverware basket can cause pitting of the stainless steel blades. Avoid mixing stainless steel and silver.

Etching

- Using too much detergent especially in soft or softened water causes damage that looks like a film but cannot be removed.
- Adjust the amount of detergent based on the water hardness. (Check Detergent Chart).
- Lower the water temperature by selecting the Normal Cycle.

Dishwasher Won't Fill

- Assure the water supply is turned on.
- Check that the overflow protector moves up and down freely. (See Overflow Protector section).

Detergent Left in Cups

- Detergent may be old. Discard and use fresh detergent.
- Be sure the dish load doesn't spray from entering the detergent cup.
- Check to see if cycle has been completed.
- Make sure items do not prevent the detergent dispenser from opening.

Vapor at Vent

- Water vapor escapes from the vent during the drying part of cycle. This is normal.
- Spilled rinse aid can cause foam and lead to overflowing. Wipe up any spills with a damp cloth.
- Check to see that dishwasher is level. (See Installation Instructions).

Normal Sounds You Will Hear

- Normal sounds include water fill, water circulation and motor sounds.
- There is a noticeable change in sound when the wash action switches between the lower and middle spray arm. This is normal since each spray arm has its own sound.
- It is normal for the dishwasher to pause (no sound) when the wash action is switching between the lower and middle spray arms.

Water in Bottom of Tub

- Water left in the tub bottom after the cycle is complete is not normal. If water remains in the bottom of the tub, the dishwasher may not be draining properly. (See Dishwasher Does not Drain Properly).

Dishwasher Leaks

- Check that the door gasket is pressed into its mounting channel, reaches to the bottom of the tub and does not extend beyond the end rib so as to interfere with door closure.
- Spilled rinse aide can cause foam and lead to overflowing. Wipe up any spills with a damp cloth.
- Check to see that the dishwasher is level. (See Installation Instructions).
- Avoid oversudsing by using the correct amount of detergent designed for automatic dishwashers.
- Check to see that dishwasher is level. (See Installation Instructions).

Dishwasher Won't Run

- Check to see if circuit breaker is tripped or if a fuse is blown.
- Make sure water supply is turned on.
- Check to see if cycle is set correctly. (See Operating Instructions).
- Is dishwasher set for Delay Start Option?
- Make sure door is closed and latched.
- Make sure START/CANCEL pad is pressed after the cycle has been selected.

Dishwasher Does Not Drain Properly

- If unit is hooked up to a food waste disposer, make sure the disposer is empty.
- Assure the knockout plug has been removed from inside the food waste disposer inlet.
- Assure the drain hose isn't kinked.
- Make sure cycle is complete, not in a pause.
- Assure the glass trap is maintained and installed properly assuring no clogs (See Care and Cleaning).

Cycle Takes a Long Time

- The cycle may have been automatically lengthened to reach key temperatures due to some factor such as a cool water supply or a large load of dishes.
- Delay Start option may have been selected.
- Choose lower temperature options to shorten the cycle.
- Cycles that are soil-sensing adjust automatically to assure a good wash - heavier soils will elicit a longer cycle response.

Dishwasher has an Odor

- Soiled dishes left in dishwasher too long can create an odor. Use Rinse Only cycle.
- There will be a "new" smell when first installed. This is normal.
- Check to see if unit is draining properly. (See Dishwasher Does Not Drain Properly).

Stains on Tub Interior

- Washing large amounts of dishware with tomato based soil can cause a pink/orange appearance. This will not affect performance and will gradually fade over time. Pre-rinsing or using the Rinse Only cycle will reduce the chance of staining. Using no heat dry option will lessen staining.

Opening the door during cycle

- If the dishwasher door is opened while the unit is running, the START/CANCEL pad must be pressed and the door shut immediately to return the unit to the selected cycle and option, this must happen within 10 minutes for the unit to continue the cycle.

Removing Spots and Film

Hard water can cause lime deposit buildup on the interior of the dishwasher. Dishes and glasses may also get spots and film for a number of reasons. (See Glassware/Flatware Spotted or Cloudy section). To remove buildup, and film, clean using the following instructions:

1. Load clean dishes and glasses in normal manner. Do not load any metal utensils or silverware.
2. Do not add detergent.
3. Select the NORMAL WASH cycle. Close and latch door. Press START/CANCEL pad.
4. Allow dishwasher to run until it starts the second water fill (approximately 10 minutes).
5. Unlatch and open door and pour 2 cups of white vinegar into the bottom of dishwasher.
6. Close and latch door and allow cycle to finish.

MAJOR APPLIANCE WARRANTY

Your appliance is covered by a one year limited warranty. For one year from your original date of purchase, Electrolux will pay all costs for repairing or replacing any parts of this appliance that prove to be defective in materials or workmanship when such appliance is installed, used and maintained in accordance with the provided instructions.

Exclusions

This warranty does not cover the following:

1. Products with original serial numbers that have been removed, altered or cannot be readily determined.
2. Product that has been transferred from its original owner to another party or removed outside the USA or Canada.
3. Rust on the interior or exterior of the unit.
4. Products purchased "as-is" are not covered by this warranty.
5. Food loss due to any refrigerator or freezer failures.
6. Products used in a commercial setting.
7. Service calls which do not involve malfunction or defects in materials or workmanship, or for appliances not in ordinary household use or used other than in accordance with the provided instructions.
8. Service calls to correct the installation of your appliance or to instruct you how to use your appliance.
9. Expenses for making the appliance accessible for servicing, such as removal of trim, cupboards, shelves, etc., which are not a part of the appliance when it is shipped from the factory.
10. Service calls to repair or replace appliance light bulbs, air filters, water filters, other consumables, or knobs, handles, or other cosmetic parts.
11. Surcharges including, but not limited to, any after hour, weekend, or holiday service calls, tolls, ferry trip charges, or mileage expense for service calls to remote areas, including the state of Alaska.
12. Damages to the finish of appliance or home incurred during installation, including but not limited to floors, cabinets, walls, etc.
13. Damages caused by: services performed by unauthorized service companies; use of parts other than genuine Electrolux parts or parts obtained from persons other than authorized service companies; or external causes such as abuse, misuse, inadequate power supply, accidents, fires, or acts of God.

DISCLAIMER OF IMPLIED WARRANTIES; LIMITATION OF REMEDIES

CUSTOMER'S SOLE AND EXCLUSIVE REMEDY UNDER THIS LIMITED WARRANTY SHALL BE PRODUCT REPAIR OR REPLACEMENT AS PROVIDED HEREIN. CLAIMS BASED ON IMPLIED WARRANTIES, INCLUDING WARRANTIES OF MERCHANTABILITY OR FITNESS FOR A PARTICULAR PURPOSE, ARE LIMITED TO ONE YEAR OR THE SHORTEST PERIOD ALLOWED BY LAW, BUT NOT LESS THAN ONE YEAR. ELECTROLUX SHALL NOT BE LIABLE FOR CONSEQUENTIAL OR INCIDENTAL DAMAGES SUCH AS PROPERTY DAMAGE AND INCIDENTAL EXPENSES RESULTING FROM ANY BREACH OF THIS WRITTEN LIMITED WARRANTY OR ANY IMPLIED WARRANTY. SOME STATES AND PROVINCES DO NOT ALLOW THE EXCLUSION OR LIMITATION OF INCIDENTAL OR CONSEQUENTIAL DAMAGES, OR LIMITATIONS ON THE DURATION OF IMPLIED WARRANTIES, SO THESE LIMITATIONS OR EXCLUSIONS MAY NOT APPLY TO YOU. THIS WRITTEN WARRANTY GIVES YOU SPECIFIC LEGAL RIGHTS. YOU MAY ALSO HAVE OTHER RIGHTS THAT VARY FROM STATE TO STATE.

If You Need Service

Keep your receipt, delivery slip, or some other appropriate payment record to establish the warranty period should service be required. If service is performed, it is in your best interest to obtain and keep all receipts. Service under this warranty must be obtained by contacting Electrolux at the addresses or phone numbers below.

This warranty only applies in the USA and Canada. In the USA, your appliance is warranted by Electrolux Major Appliances North America, a division of Electrolux Home Products, Inc. In Canada, your appliance is warranted by Electrolux Canada Corp. Electrolux authorizes no person to change or add to any obligations under this warranty. Obligations for service and parts under this warranty must be performed by Electrolux or an authorized service company. Product features or specifications as described or illustrated are subject to change without notice.

USA
1.800.944.9044
Frigidaire
10200 David Taylor Drive
Charlotte, NC 28262

Canada
1.800.265.8352
Electrolux Canada Corp.
5855 Terry Fox Way
Mississauga, Ontario, Canada
LSV 3E4